

## ICPU-6 for imc ARGUSfit

### 6-channel measuring amplifier for voltage and IEPE sensors



The ICPU-6 from the imc ARGUSfit series is a 6-channel measurement amplifier that can be used in conjunction with an imc ARGUS system (or base unit) to which it is directly docked with its housing.

Individually isolated, conditioned and configurable differential channels capture:

- IEPE or ICP sensors (current fed sensors 4 mA)
- Voltage (AC and DC coupling)

Direct connection of IEPE compatible sensors (ICP™, DELTATRON®, PIEZOTRON® sensors) is made via BNC connectors.

### Highlights

- Channel individually galvanically isolated
- 220 kHz bandwidth at max. 500 kSps/channel sampling rate
- 24 bit digitisation, internal processing and data resolution
- Status LEDs to indicate connection errors (cable break or short circuit)
- 6 channels in extremely compact design, clickable to imc ARGUSfit systems

### Typical applications

- Typical applications
- Acoustics and NVH
- esp. also in connection with imc WAVE software
- IEPE acceleration sensors and microphones
- Explosion testing with ICP-based blast pressure sensors
- Power measurement on 48 V systems (e.g. small electric vehicles) in connection with current measurement via shunt or current transformer

### imc ARGUSfit: Flexible modular platform for fast measurement systems

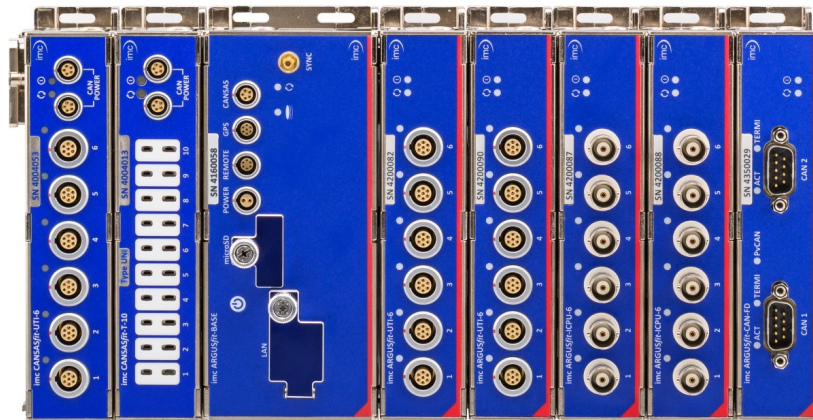

Based on an imc ARGUSfit base unit, imc ARGUSfit measurement amplifier and interface modules can be combined to form complete systems by means of a robust click mechanism, which can even integrate imc CANASfit modules. The click connectors provide the electrical connection to the power supply and system bus.

For expansion to decentralized distributed topologies, the fast internal ARGFT system bus can be converted to fiber optic cables by means of a clickable fiber converter module.

The entire system can be controlled via a common Ethernet connection (LAN/WLAN) with a PC (imc STUDIO software) and can be networked and operated synchronously and uniformly with all other imc data acquisition instrument series. Furthermore, it can also be operated autonomously and stand-alone without PC with data storage on microSD.

### Dimensions

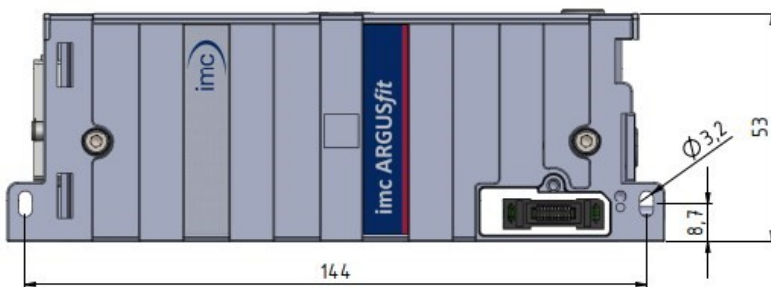

imc ARGUSfit ICPU-6

Module shown in standard operating position (terminal connections upwards)

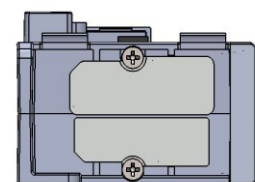
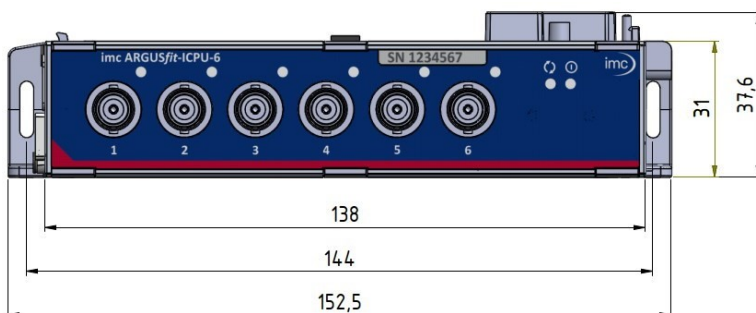

left module panel with parking position for the covers of the module connectors

### Overview of the available variants

Order Code	properties	article no.
ARGFT/ICPU-6	IEPE and voltage amplifier (-40°C... +85°C)	11400209
ARGFT/ICPU-6-EC	variant for extended condensation	11410203

### Included accessories

Documents
Getting started with imc ARGUSfit (one copy per delivery)
Device certificate

### Optional accessories

Fiber-Converter Set		
ARGFT/FIBER-CONVERTER-SET	Media converter for the ARGUS system bus Includes: 2 converter modules, 2x SFP+ transceiver, 5 m fiber optic cable, AC/DC power adaptor and a power plug	11400225

Mounting accessories		
CANFT/BRACKET-DIN	Mounting on DIN-Rail (top hat rail) for imc ARGUSfit and imc CANSASfit	12100029
CANFT/BRACKET-MAG	Mounting with magnet system for imc ARGUSfit and imc CANSASfit	12100030

Documents		
SERV/CAL-PROT	Calibration protocol per amplifier imc manufacturer calibration certificate with measurement values and list of calibration equipment used (pdf).	150000566
SERV/CAL-PROT-PAPER	Calibration protocol per amplifier (paper print) imc manufacturer calibration certificate with measurement values and list of calibration equipment used with signature and seal.	150000578

Device certificates and calibration protocols: Detailed information on certificates supplied, the specific contents, underlying standards (e.g. ISO 9001 / ISO 17025) and available media (pdf etc.) can be found on our website, or you can contact us directly.

## Technical Specs - ARGFT/ICPU-6

### General



Inputs, measurement modes		
Parameter	Value	Remarks
Inputs	6	differential, analog
Measurement modes	voltage measurement IEPE / ICP (Integrated Electronics Piezo Electric)	
Supported sensors	IEPE / ICP	
TEDS (Transducer Electronic Data Sheet)	supported on the hardware side Software support (imc STUDIO): in preparation	
Connector / socket Measuring input Module connector	BNC  Click-connection (with covering caps)	for the supply and system bus of directly connected modules without further cables, see data sheet of the ARGFT base unit

Sampling rate, bandwidth, filter			
Parameter	Value typ.	min. / max.	Remarks
Sampling rate		≤500 kHz	individually selectable per channel
Bandwidth	0 Hz to 220 kHz 0 Hz to 200 kHz		-3 dB 0.1 dB
Filter Type Characteristic  Cut-off frequency  Order Anti-aliasing filter	low pass  Mean, Butterworth, Bessel, AAF  10 Hz to 50 kHz  8 <sup>th</sup> Cauer 8 <sup>th</sup> order with $f_{\text{cut-off}} = 0.4 f_s$		individually selectable; mean and AAF: adapted automatically, according to selected output rate  -3 dB, 1 - 2 - 5 steps digital filter in addition to hardware filter  $f_s$ : output rate
Resolution	24 bit		data output: 32 bit Float (24 bit mantissa)

Isolation		
Parameter	Value	Remarks
Isolation	galvanically isolated	
channel-to-case (CHASSIS)	±60 V	test voltage: ±300 V (10 s)
channel to power supply	±60 V	test voltage: ±300 V (10 s)
channel-to-channel	±60 V	test voltage: ±300 V (10 s)

Power supply of the module			
Parameter	Value typ.	min. / max.	Remarks
Input supply voltage		7 V to 50 V DC 9.5 V to 50 V DC	operating upon power up power supply via base unit, fiber converter or UPS module
Power consumption		4 W / 5 W (min.)/(max.)	plus up to 1 W for sensor supply, plus 2 %/10 K
Isolation		±60 V	to case (CHASSIS), isolation impedance ≥1 MΩ

Pass through power limits for directly connected modules (click-mechanism)		
Parameter	Value	Remarks
Max. current	5 A	at 85 °C current rating of click connector to ARGFT modules
	60 W at 12 V DC 120 W at 24 V DC	typ. DC vehicle voltage AC/DC power adaptor and installations

Status-LED		
Parameter	Value	Remarks
Power-LED green	 power active	
Status-LED green blue magenta yellow red	 multicolor OK init, etc. firmware update prepare configuration error	global status of module
Channel-Status-LED off green red	channel passive channel active no sensor, short circuit	status for each channel  error (in case of overload, no IEPE sensor connected or short-circuit of sensor)

### Measurement modes

DC voltage measurement				
Parameter	Value typ.		min. / max.	Remarks
Input ranges	±60 V, ±50 V, ±25 V, ±10 V, ±5 V, ... to ±25 mV			input range ±60 V (nominal working voltage according to low voltage directive SELV) is valid up to 100 V without limitation
Max. overvoltage			±200 V	
Input coupling			DC	
Input impedance	1.3 MΩ 10 MΩ		±1% ±2%	input range >±10 V input range ≤±10 V
Gain error			0.02% + 0.003%/K·ΔT <sub>a</sub>	of the reading ΔT <sub>a</sub> =  T <sub>a</sub> - 25°C ; with T <sub>a</sub> = ambient temperature
Offset error			0.02% + 0.002%/K·ΔT <sub>a</sub> 25 μV + 2μV/K·ΔT <sub>a</sub>	of the input range input range >±100 mV ΔT <sub>a</sub> =  T <sub>a</sub> - 25°C ; with T <sub>a</sub> = ambient temperature input range ≤±100 mV ΔT <sub>a</sub> =  T <sub>a</sub> - 25°C ; with T <sub>a</sub> = ambient temperature
Signal-to-Noise Ratio typ. SNR	band width 0.1 Hz ... 220 kHz	band width 0.1 Hz ... 20 kHz	band width 0.1 Hz... 1 kHz	range: 60 V 50 V 25 V 10 V 5 V 2.5 V 1 V 500 mV 250 mV 100 mV 50 mV 25 mV

AC voltage measurement				
Parameter	Value typ.		min. / max.	Remarks
Input ranges	±60 V, ±50 V, ±25 V, ±10 V, ±5 V, ... to ±25 mV			input range ±60 V (nominal working voltage according to low voltage directive SELV) is valid up to 100 V without limitation
Max. overvoltage			±200 V	
Input coupling	AC			
cut-off frequency	1 Hz		±8%	-3 dB; 0.1% settling time approx. 3 s
Max. Signal (AC + DC)	±60 V ±12 V			range: >10 V ≤10 V
Input impedance	1.3 MΩ 10 MΩ		±1% ±2%	input range >±10 V input range ≤±10 V
Gain error			0.05% + 0.003%/K·ΔT <sub>a</sub>	of the reading ΔT <sub>a</sub> =  T <sub>a</sub> - 25°C ; with T <sub>a</sub> = ambient temperature
Signal-to-Noise Ratio typ. SNR	band width 0.1 Hz ... 220 kHz	A- weighted	band width 0.1 Hz... 1 kHz	range:
	91 dB	102 dB	113 dB	60 V
	93 dB	104 dB	116 dB	50 V
	88 dB	99 dB	111 dB	25 V
	98 dB	110 dB	121 dB	10 V
	99 dB	110 dB	122 dB	5 V
	98 dB	107 dB	120 dB	2.5 V
	98 dB	112 dB	119 dB	1 V
	97 dB	108 dB	118 dB	500 mV
	94 dB	104 dB	114 dB	250 mV
	86 dB	98 dB	106 dB	100 mV
	80 dB	92 dB	100 dB	50 mV
	74 dB	86 dB	94 dB	25 mV

IEPE measurement				
Parameter	Value typ.	min. / max.		Remarks
Input ranges	±10 V, ±5 V, ±2,5 V, ±1 V, ... to ±25 mV			
Max. overvoltage		±200 V		
Input coupling	IEPE			
cut-off frequency	1 Hz	±8%		-3 dB; 0.1% settling time approx. 3 s
Input impedance	0.8 MΩ			
Gain error		0.05% + 0.003%/K·ΔT <sub>a</sub>		of the reading ΔT <sub>a</sub> =  T <sub>a</sub> - 25°C ; with T <sub>a</sub> = ambient temperature
Signal-to-Noise Ratio typ. SNR	band width 0.1 Hz ... 220 kHz	A- weighted	band width 0.1 Hz... 1 kHz	range:
	98 dB	110 dB	112 dB	10 V
	97 dB	109 dB	110 dB	5 V
	95 dB	107 dB	109 dB	2.5 V
	88 dB	105 dB	108 dB	1 V
	82 dB	101 dB	103 dB	500 mV
	76 dB	96 dB	97 dB	250 mV
	68 dB	88 dB	89 dB	100 mV
	62 dB	82 dB	83 dB	50 mV
56 dB	76 dB	77 dB	25 mV	

Sensor supply			
Parameter	Value typ.	min. / max.	Remarks
IEPE constant current source	4.2 mA	±5%	
Output voltage	+20.2 V to 1.8 V	+20 V to 2 V	
'Short circuit' detection	1.8 V	<1.4 V	sensor voltage
'Non sensor' detection	20.4 V	>22 V or <2 mA	sensor current
Max. Overvoltage		±200 V	



## Operating conditions

Operating conditions		
Parameter	Value	Remarks
Operating environment	dry, non corrosive environment within specified operating temperature range	
Ingress protection class	IP50	with correctly mounted covers over both module connectors
Pollution degree	2	
Operating temperature range	-40 °C to +85 °C	standard version: without condensation "-EC" version: temporary condensation allowed
Shock- and vibration resistance	IEC 60068-2, IEC 61373 IEC 60062-2-64 category 1, class A and B MIL-STD-810 Rail Cargo Vibration Exposure U.S. Highway Truck Vibration Exposure	
Extended shock- and vibration resistance	upon request	specific tests or certification upon request
Dimensions (L x W x H)	approx. 153 x 40 x 54 mm	including mounting flanges and click mechanism, see mechanical <a href="#">drawings</a> 
Weight	0.33 kg	



An Axiometrix Solutions Brand

## Contact imc

### Address

imc Test & Measurement GmbH  
Voltastr. 5  
13355 Berlin

Phone: (Germany): +49 30 467090-0

E-Mail: [info@imc-tm.de](mailto:info@imc-tm.de)

Internet: <https://www.imc-tm.com>

### Tech support

If you have problems or questions, please contact our tech support:

Phone: (Germany): +49 30 467090-26

E-Mail: [hotline@imc-tm.de](mailto:hotline@imc-tm.de)

Internet: <https://www.imc-tm.com/service-training/>

### imc ACADEMY - Training center

The safe handling of measurement devices requires a good knowledge of the system. At our training center, experienced specialists are here to share their knowledge.

E-Mail: [schulung@imc-tm.de](mailto:schulung@imc-tm.de)

Internet: <https://www.imc-tm.com/service-training/imc-academy>

### International partners

You will find the contact person responsible for you in our overview list of imc partners:

Internet: <https://www.imc-tm.com/imc-worldwide/>

### imc @ Social Media

<https://www.facebook.com/imcTestMeasurement>

<https://www.youtube.com/c/imcTestMeasurementGmbH>

[https://twitter.com/imc\\_de](https://twitter.com/imc_de)

<https://www.linkedin.com/company/imc-test-&-measurement-gmbh>